

# Малюнки на меблевих фасадах з МДФ

## Внутрішні фрези

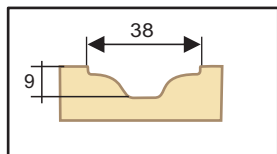

### Фреза № 1

Для малюнків:  
1, 2, 6, 7, 13, 15, 19, 36.  
"Катнтри". "Вестерн"

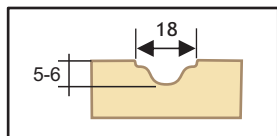

### Фреза № 2

Для малюнків:  
3, 8, 10, 17, 20, 21, 29, 37

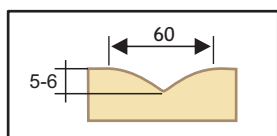

### Фреза № 3

Для малюнків:  
18, 23, 27

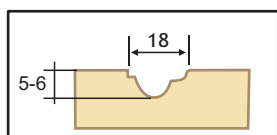

### Фреза № 4

Для малюнків:  
49

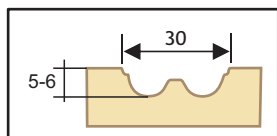

### Фреза № 5

Для малюнків:  
14, 29

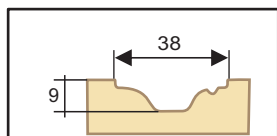

### Фреза № 6

Для малюнків:  
53

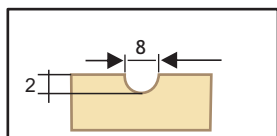

### Фреза № 7

Для малюнків:  
4, 5, 9, 33, 34, 35, 36, 37

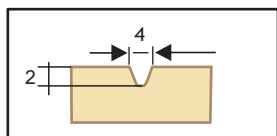

### Фреза № 8

Для малюнків:  
16, 31, 32, 38, 58, 59

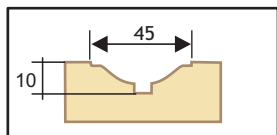

### Фреза № 9

Для малюнків:  
1, 2, 6, 7, 13, 26, 31, 36,  
"Кантри", "Вестерн"

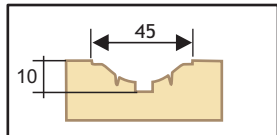

### Фреза № 10 (9+8)

Для малюнків:  
31

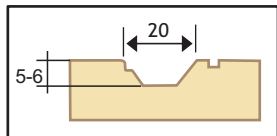

### Фреза № 11

Для малюнків:  
38

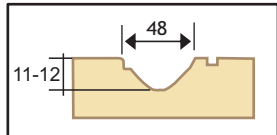

### Фреза № 12

Для малюнків:  
58, 59, 60

## Кромочні фрези

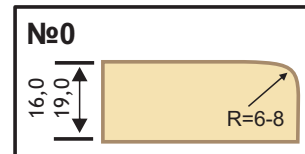

### №0

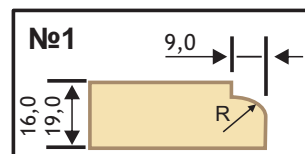

### №1

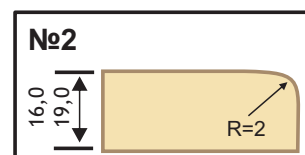

### №2

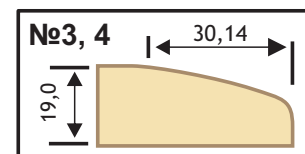

### №3, 4

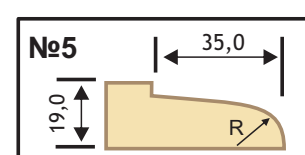

### №5

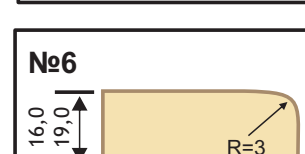

### №6



### №7

## Пілястри

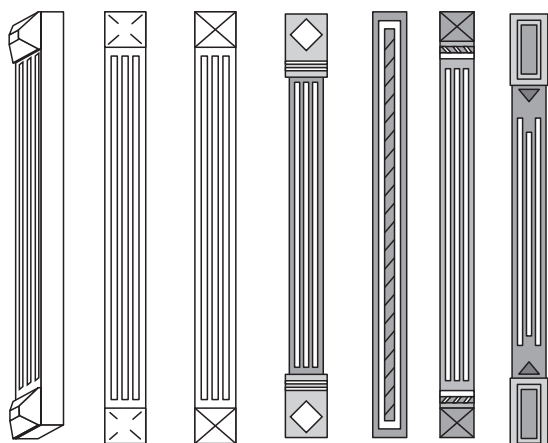

П (25 мм) П-1 (16 и 19 мм) П-2 (16 и 19 мм) П-3 (16 и 19 мм) П-4 (16 и 19 мм) П-5 (16 и 19 мм) П-6 (16 и 19 мм)

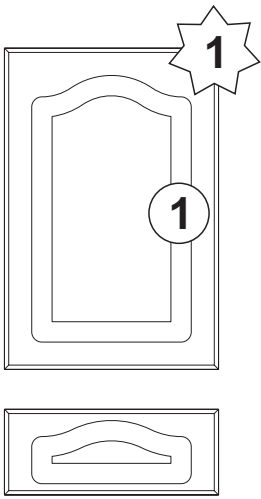

Мал. № 1

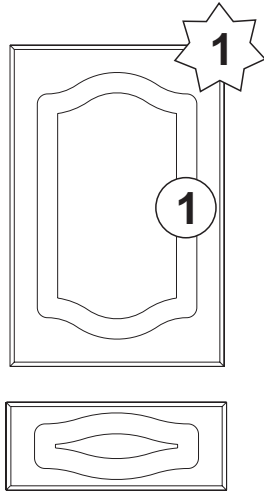

Мал. № 2

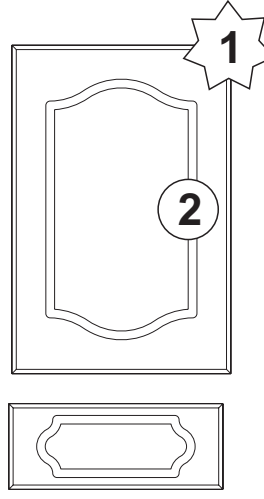

Мал. № 3

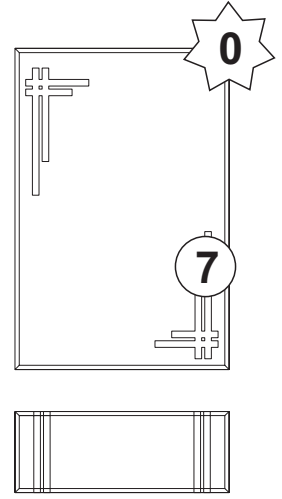

Мал. № 4

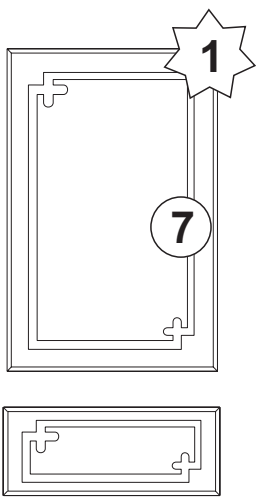

Мал. № 5

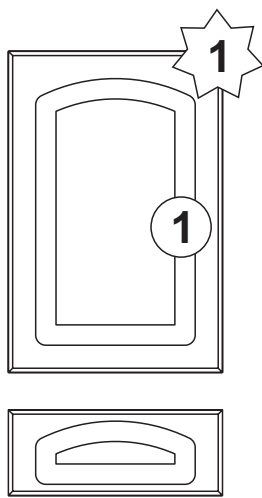

Мал. № 6

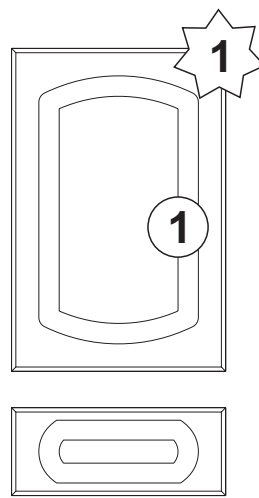

Мал. № 7

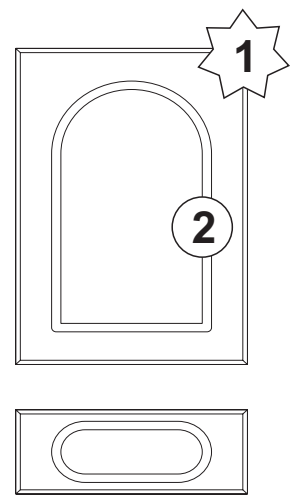

Мал. № 8

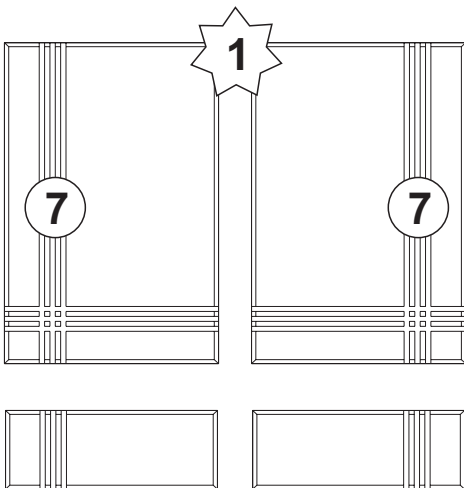

Левый

Правый

Мал. № 9

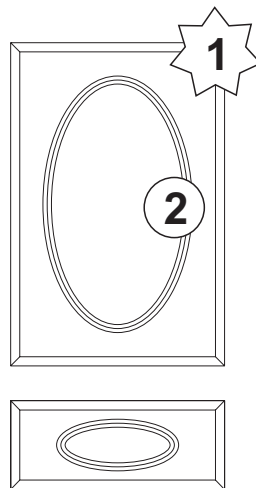

Мал. № 10

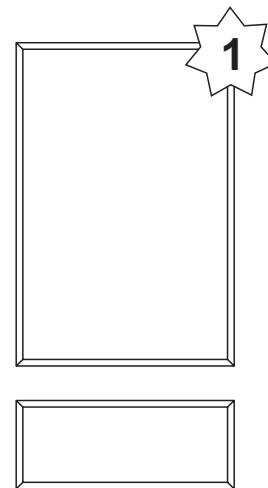

Мал. № 11



- кромочна фреза



- фреза малюнку

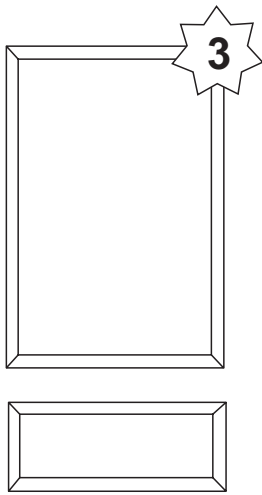

Мал. № 12

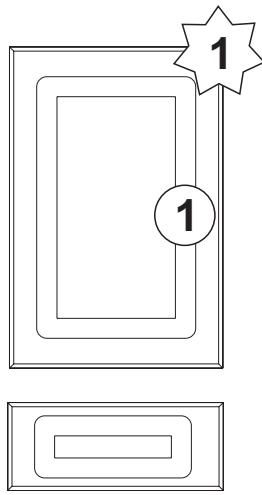

Мал. № 13

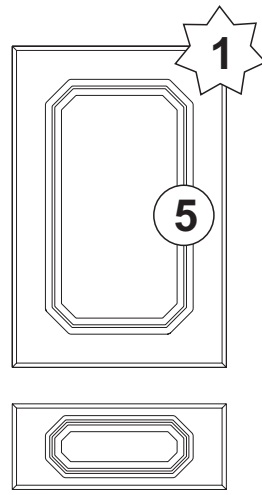

Мал. № 14

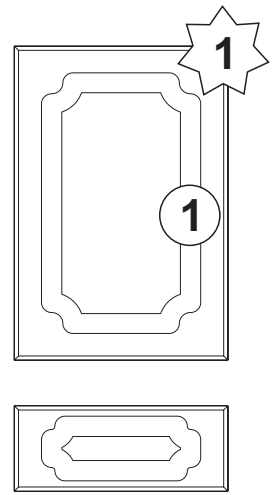

Мал. № 15

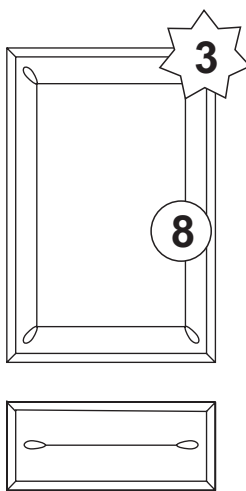

Мал. № 16

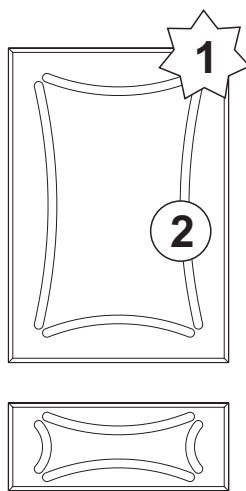

Мал. № 17

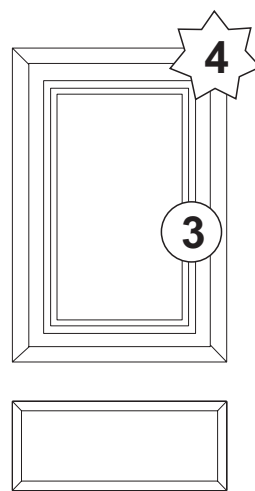

Мал. № 18

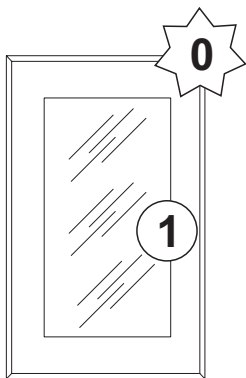

Вітрина  
Мал. № 19

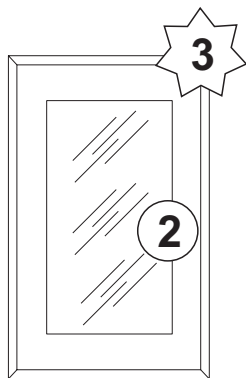

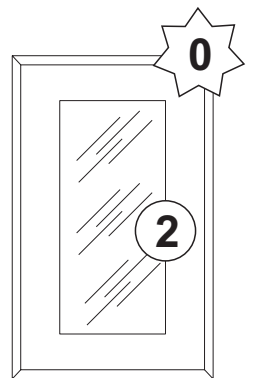

Вітрина  
Мал. № 20

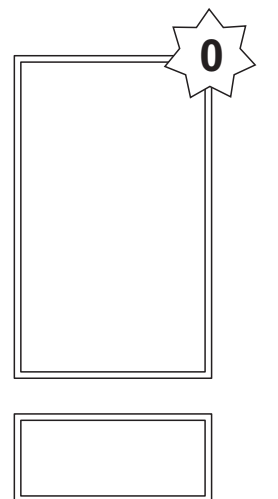

Вітрина  
Мал. № 21



Мал. № 22

-  - кромочна фреза
-  - фреза малюнку

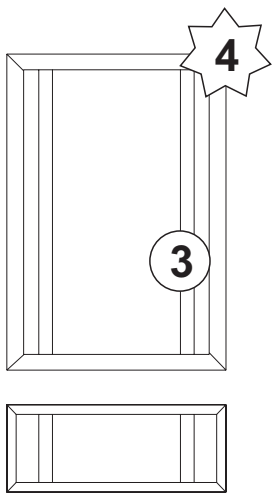

Мал. № 23

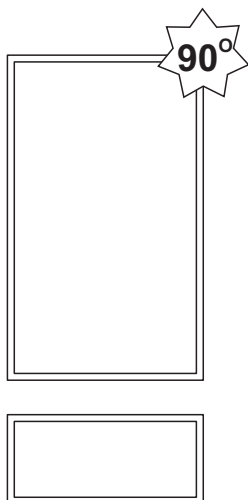

Мал. № 24

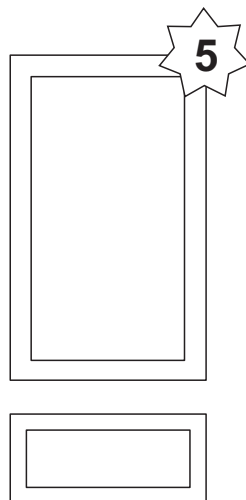

Мал. № 25

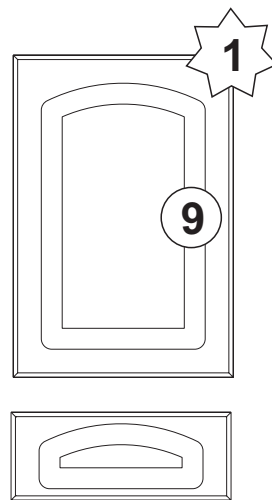

Мал. № 26

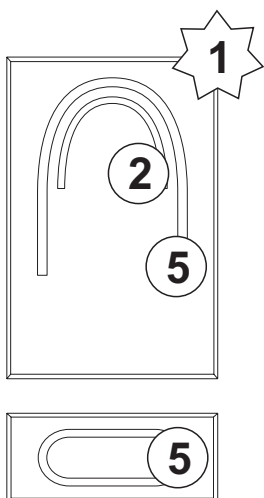

Мал. № 29

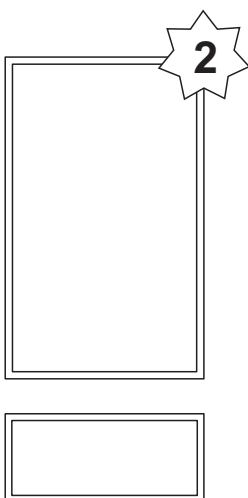

Мал. № 30

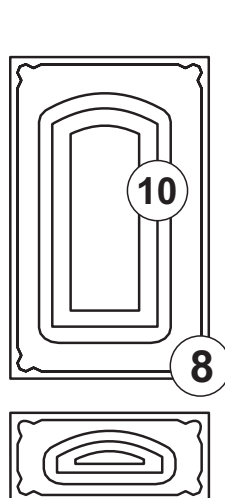

Мал. № 31

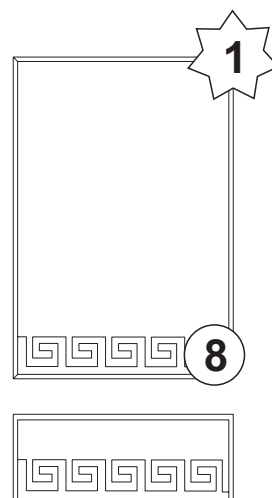

Мал. № 32

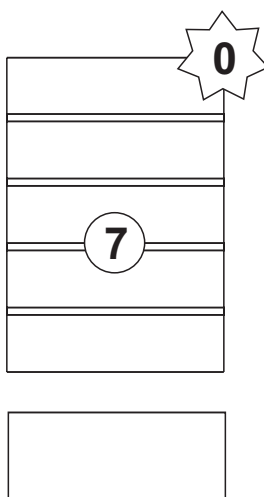

Мал. № 33

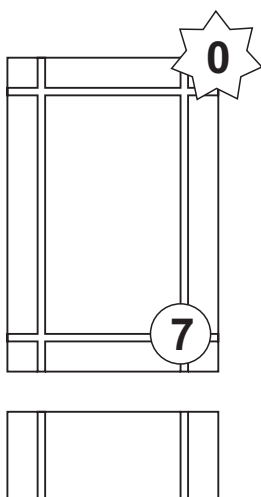

Мал. № 34

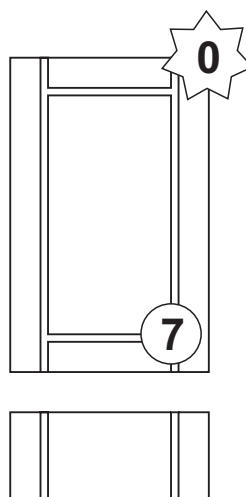

Мал. № 35

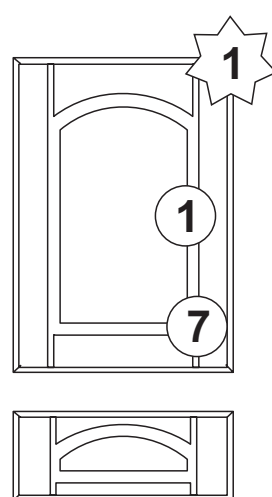

Мал. № 36

**1** - кромочна фреза

**1** - фреза малюнку

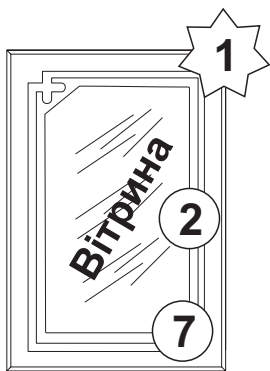

Мал. № 37

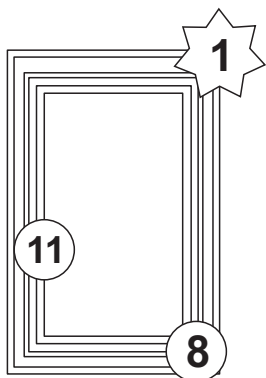

Мал. № 38

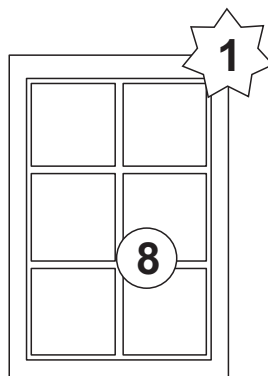

Мал. № 38  
шпрос

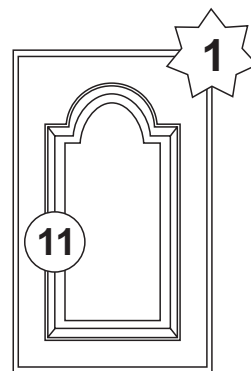

Мал. № 39

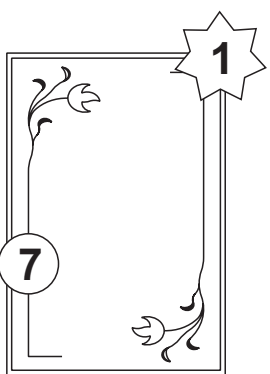

Мал. № 40

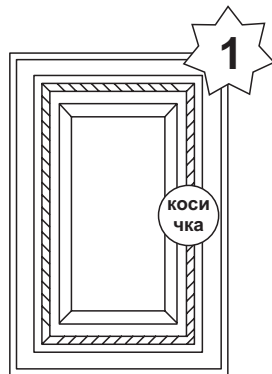

Мал. № 41

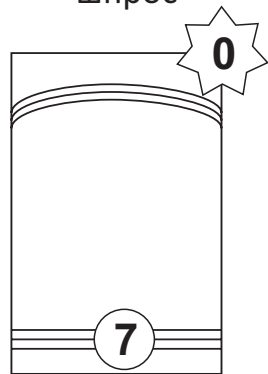

Мал. № 44

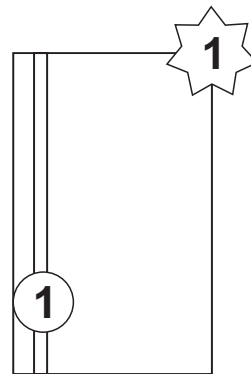

Мал. № 45

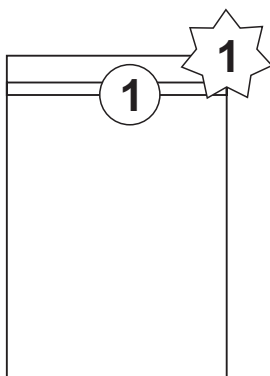

Мал. № 46

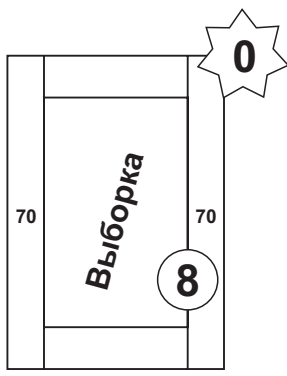

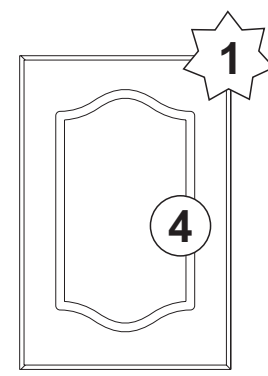

Мал. № 47  
(16+3)

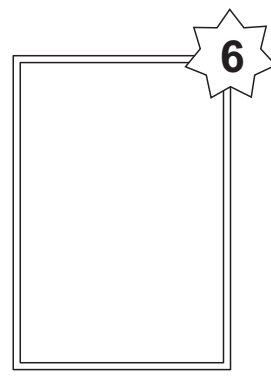

Мал. № 49



Мал. № 50

-  - кромочна фреза
-  - фреза малюнку

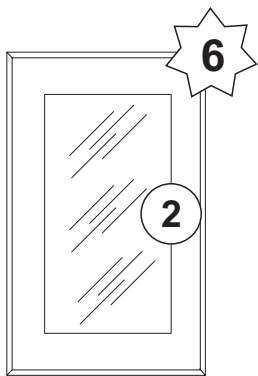

Вітрина  
Мал. № 51

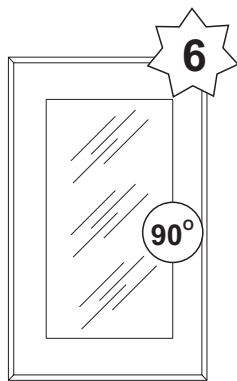

Вітрина  
Мал. № 52

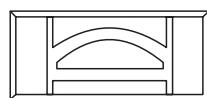
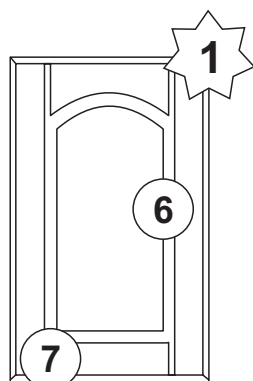

Мал. № 53

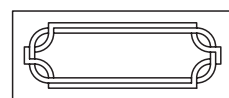
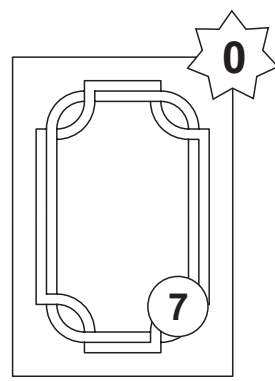

Мал. № 55

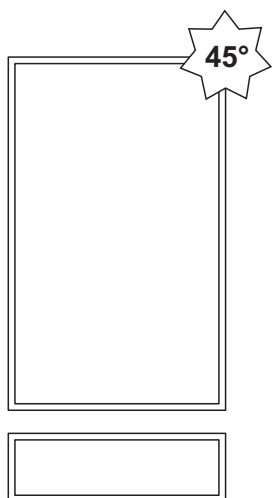

Мал. № 56

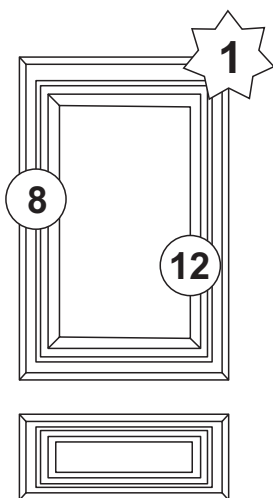

Мал. № 58

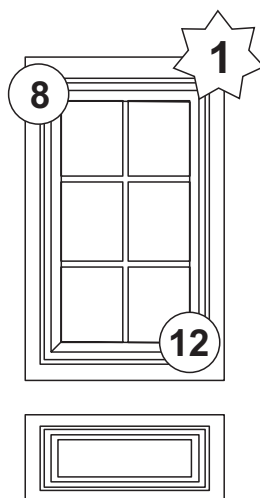

Мал. № 58  
шпрос

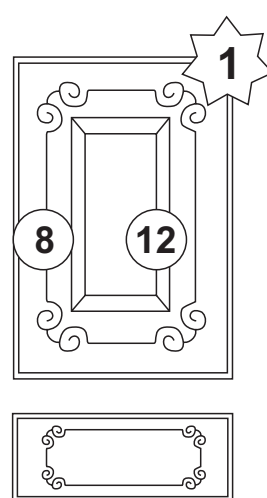

Мал. № 59

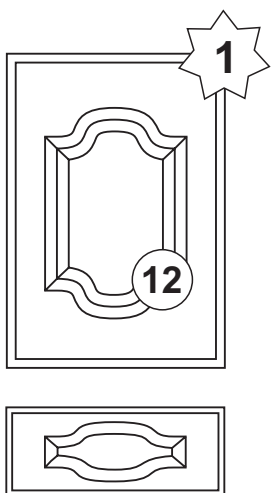

Мал. № 60

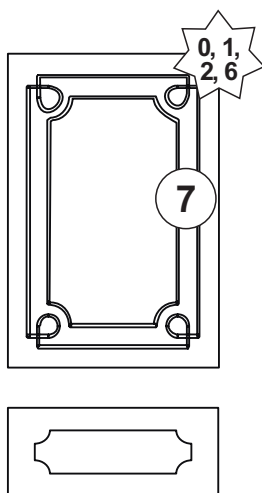

Мал. 61

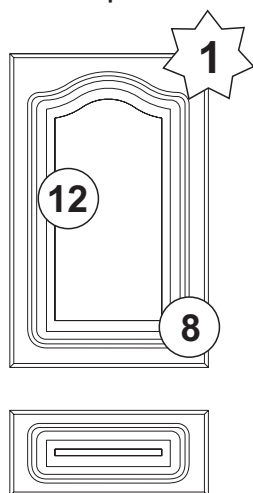

Мал. № 65

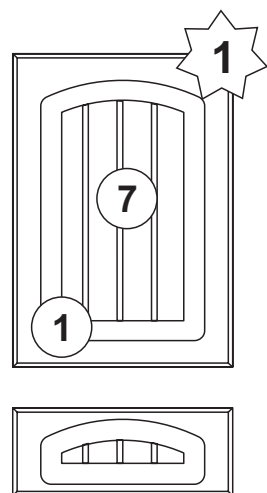

Мал. № 66

**1** - кромочна фреза

**1** - фреза малюнку

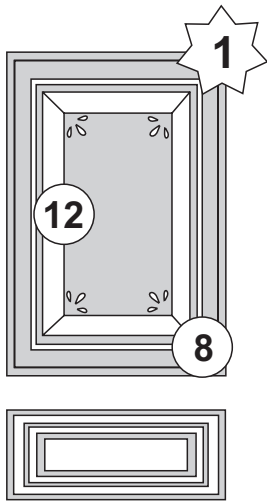

Мал.№ 67

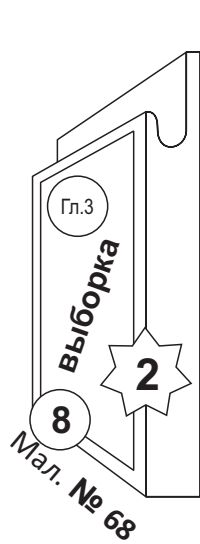

Мал. № 68

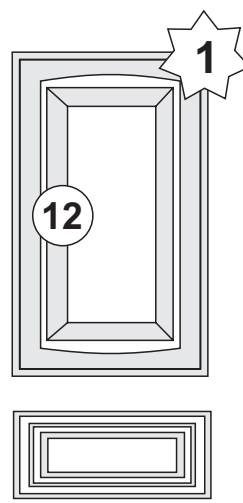

Мал. № 69

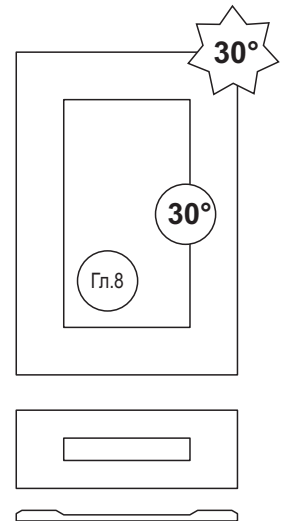

Мал.№ 70  
(10+8)

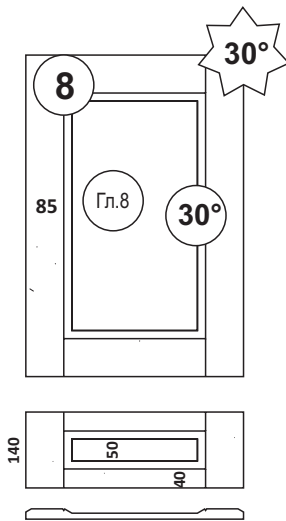

Мал. № 71  
(10+8)

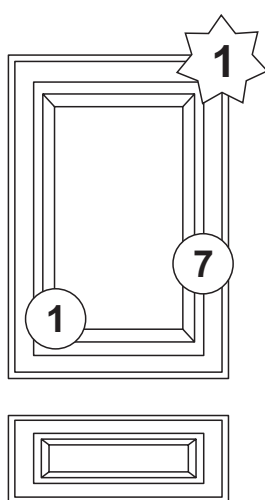

Мал. № 73

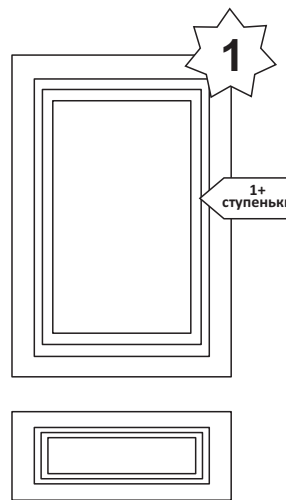

Мал. № 74

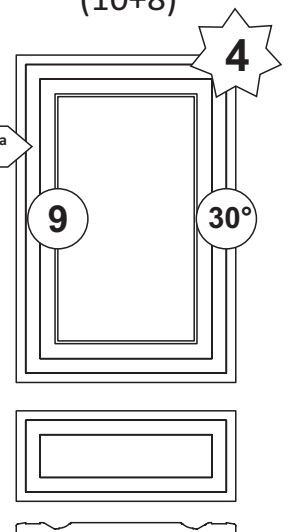

Мал. № 80

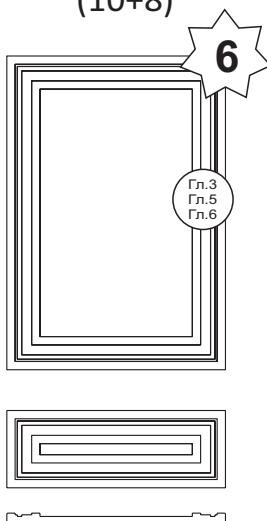

Мал.№ 81

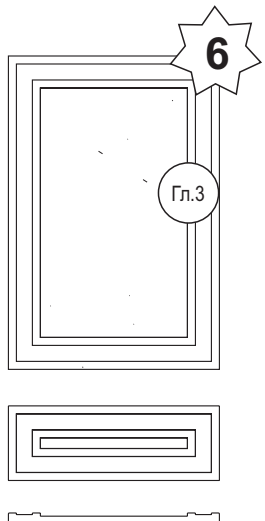

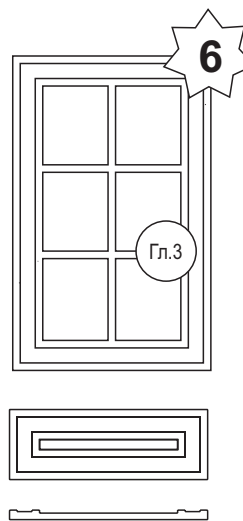

Мал. № 82

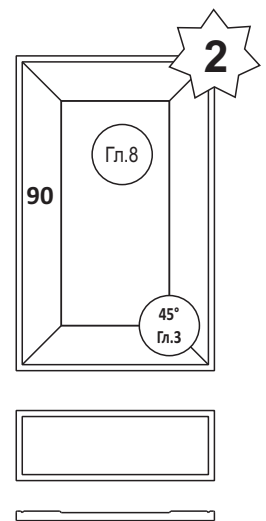

Мал. № 82  
шпрос



Мал. № 83

-  - кромочна фреза
-  - фреза малюнку

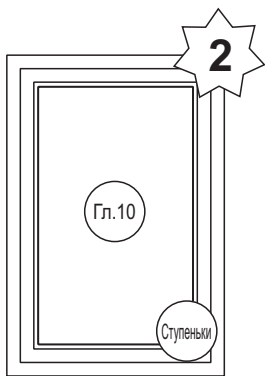

Мал. № 84

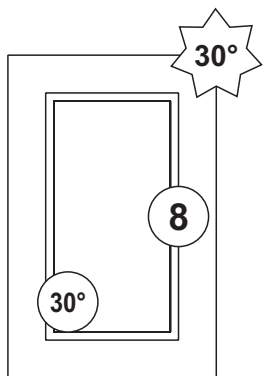

Мал. № 85

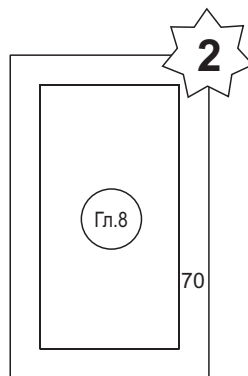

Мал. № 86

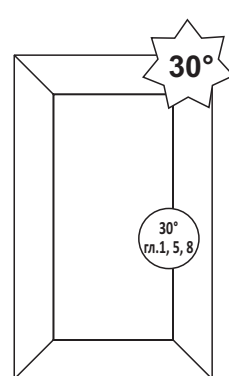

Мал. № 87

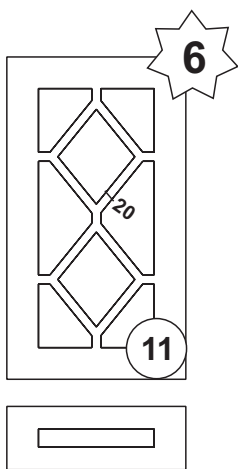

Мал. № 88

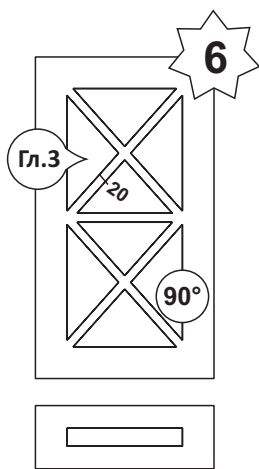

Мал. № 89

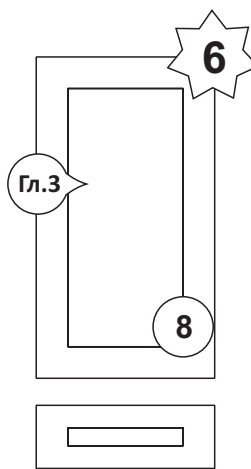

Мал. № 90

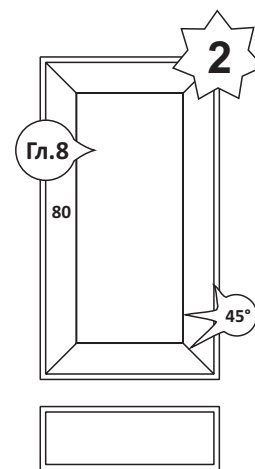

Мал. № 91

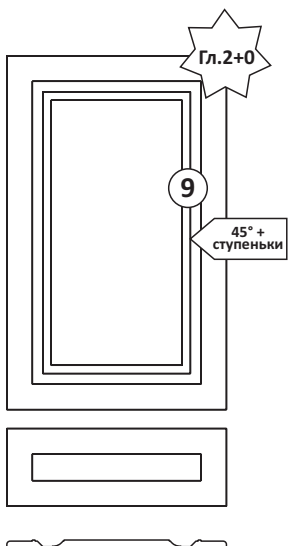

Мал. № 92

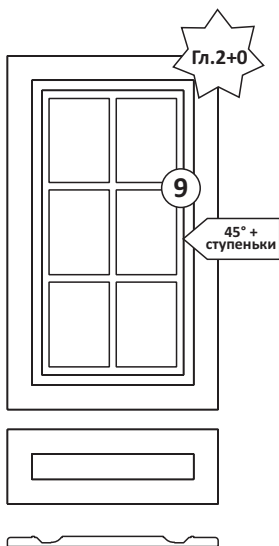

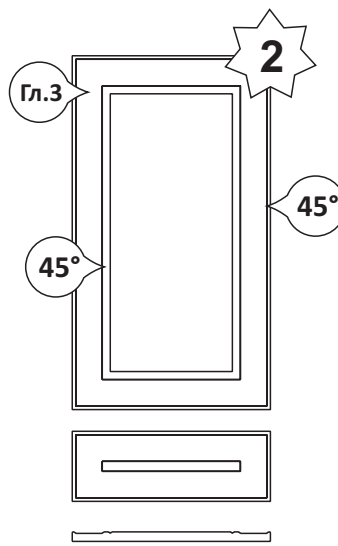

Мал. № 92  
шпрос

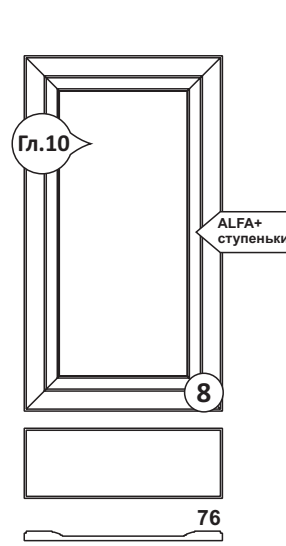

Мал. № 93



Мал. № 95

-  - кромочна фреза
-  - фреза малюнку



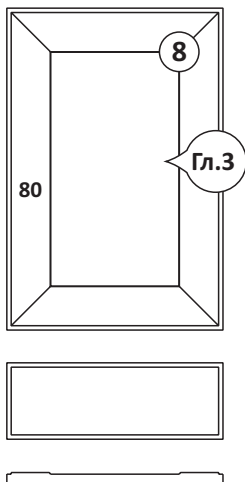

Мал. № 98

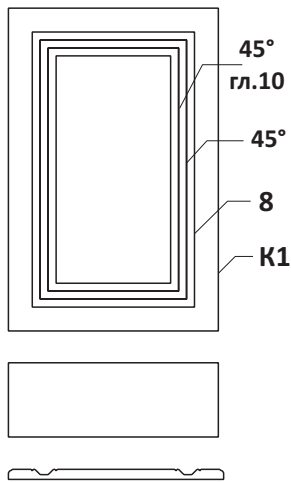

Мал. № 99

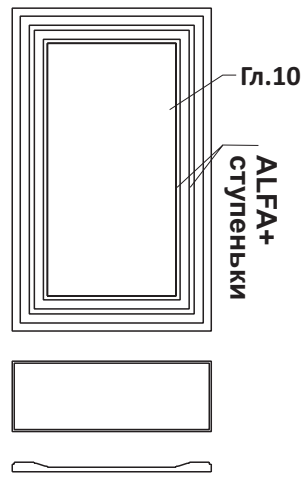

Мал. № 100

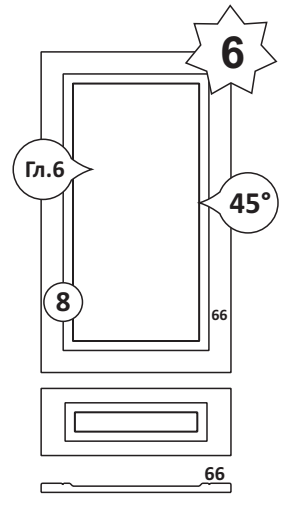

Мал. № 101

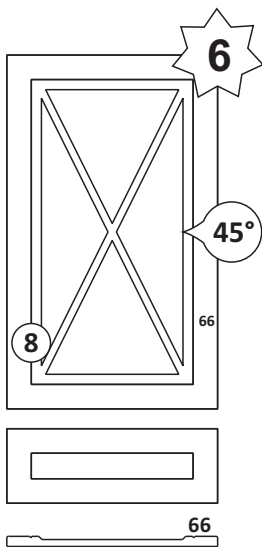

Мал. № 101  
шпрос

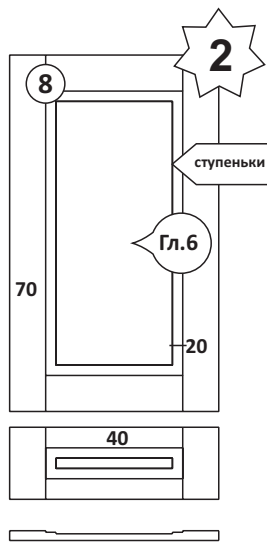

Мал. № 102

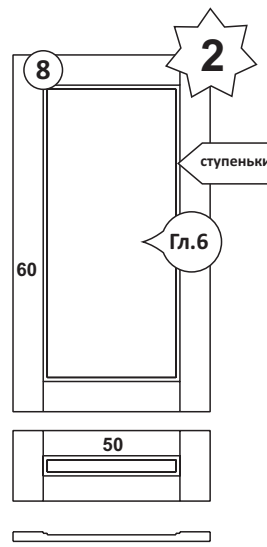

Мал. № 103



Мал. № 104

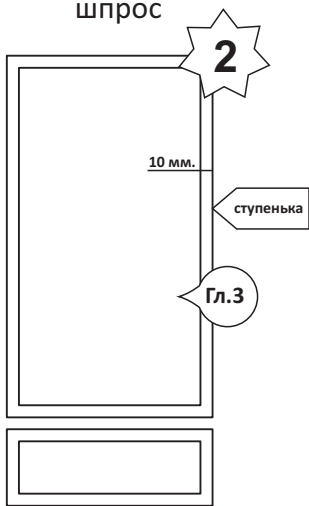

Мал. № 105

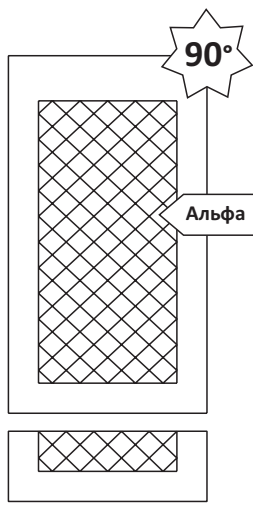

Мал. № 106

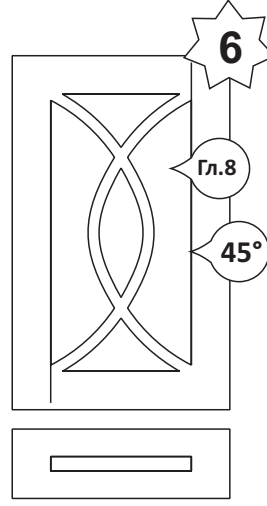

Мал. № 107

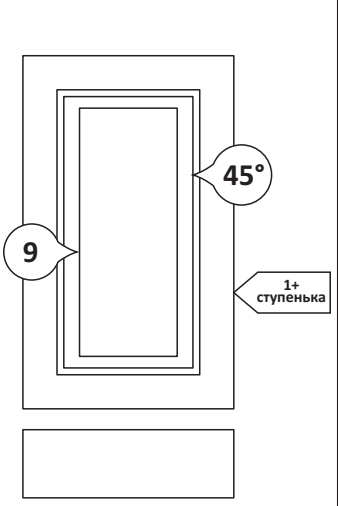

Мал. № 108

**1** - кромочна фреза

**1** - фреза малюнку

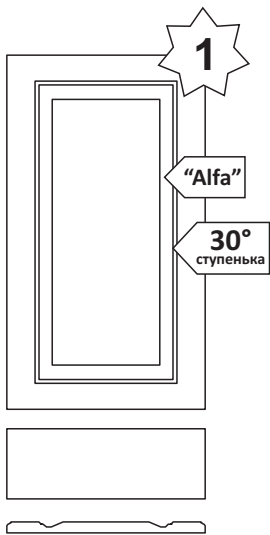

Мал. № 110

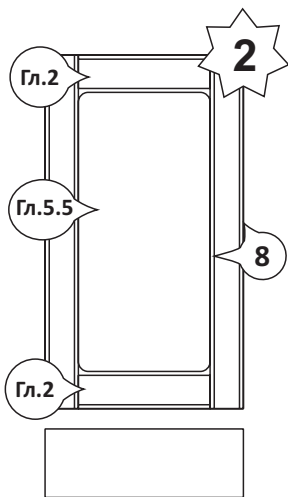

Мал. № 111

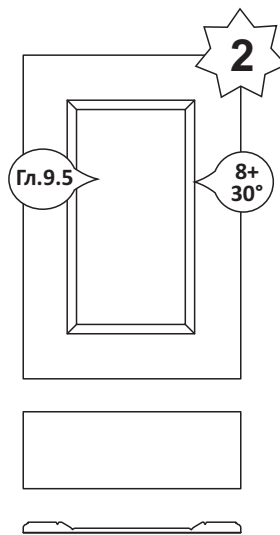

Мал. № 112

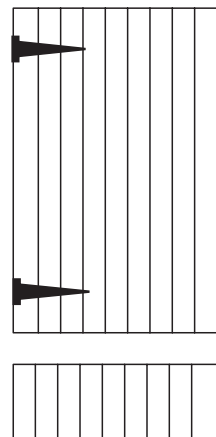

Мал. № 113

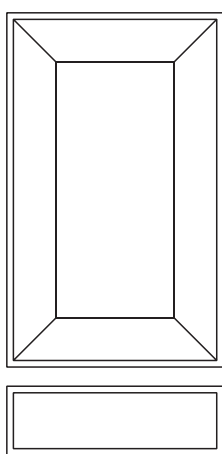

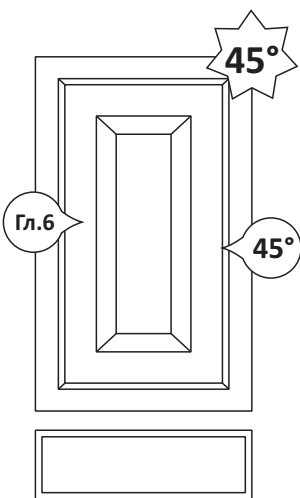

Мал. № 114

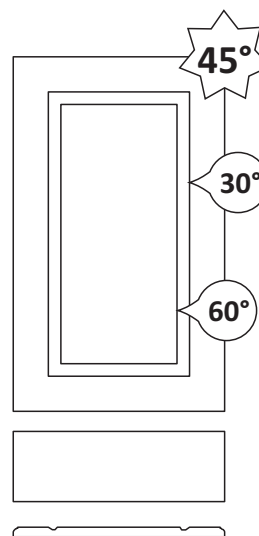

Мал. № 115



Мал. Модерн

-  - кромочна фреза
-  - фреза малюнку

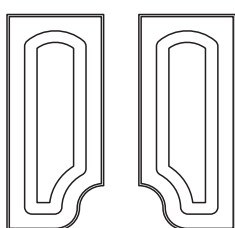

“Вестерн”

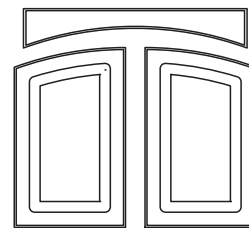

“Кантри”

# Меблеві фасади / стінові панелі

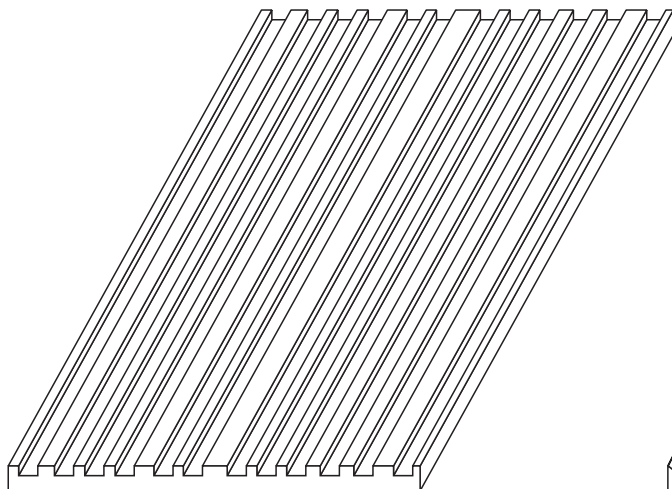

Мал. № 116  
(Випадкові варіанти)

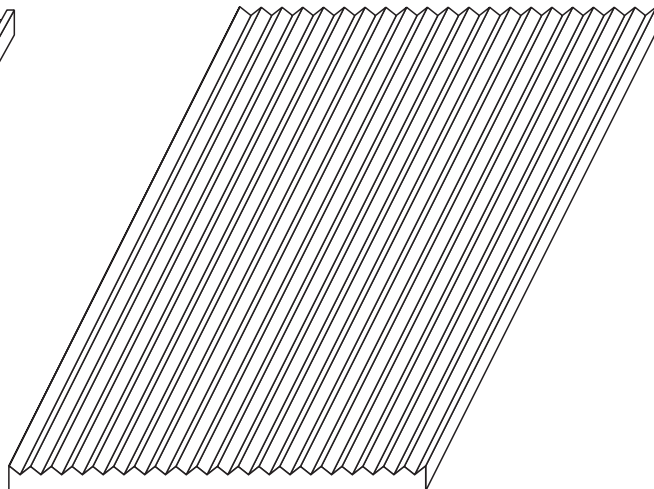

Мал. № 117

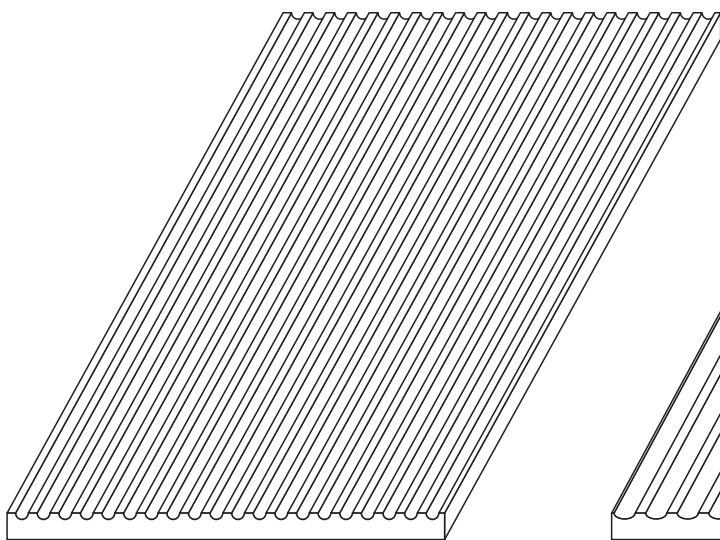

Мал. № 118

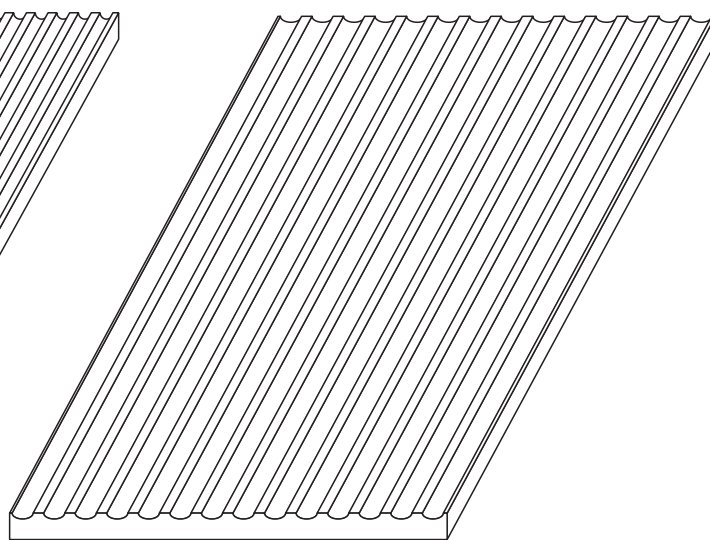

Мал. № 119

# Меблеві фасади / стінові панелі

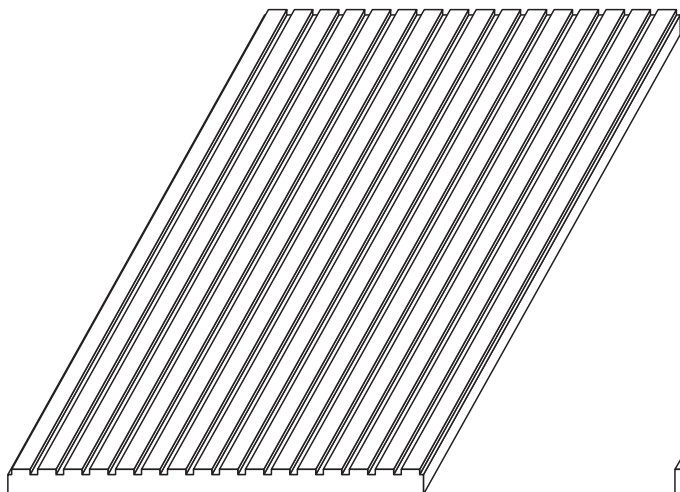

Мал. № 120

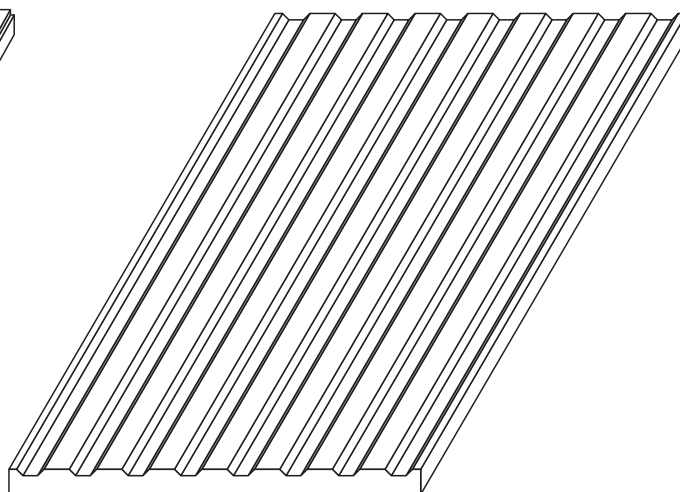

Мал. № 121

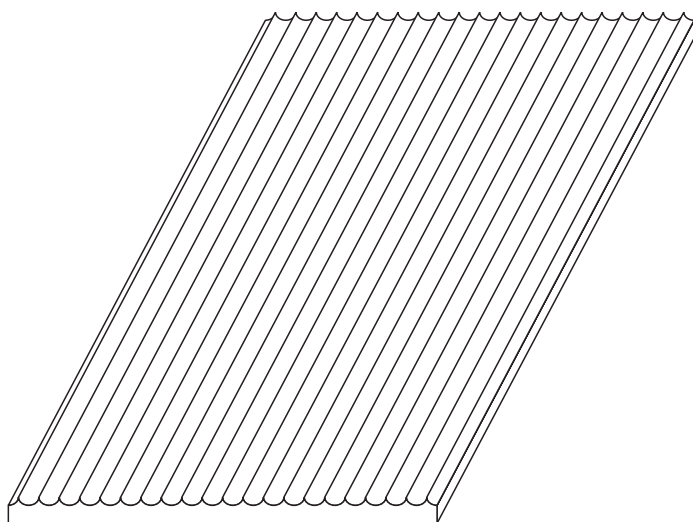

Мал. № 122

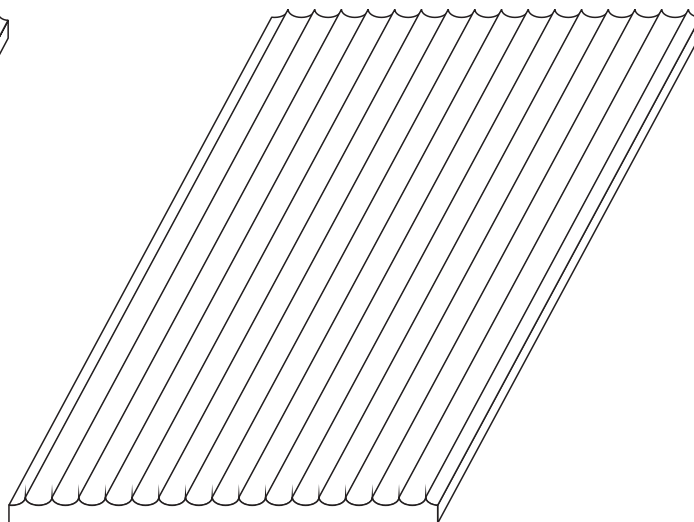

Мал. № 123

# Меблеві фасади / стінові панелі

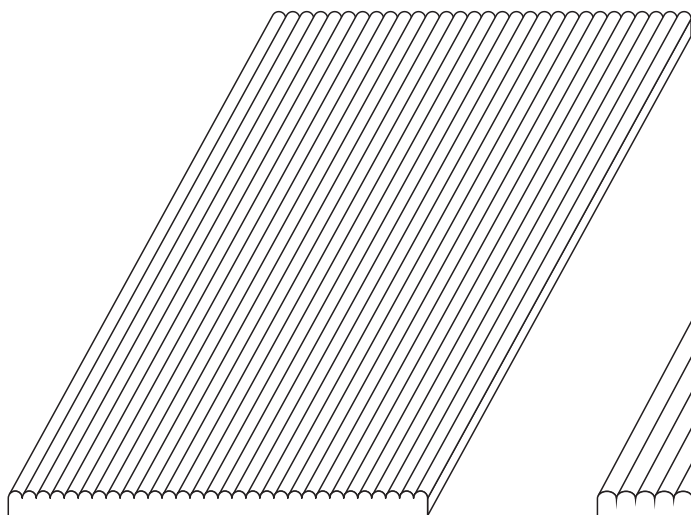

Мал. № 124

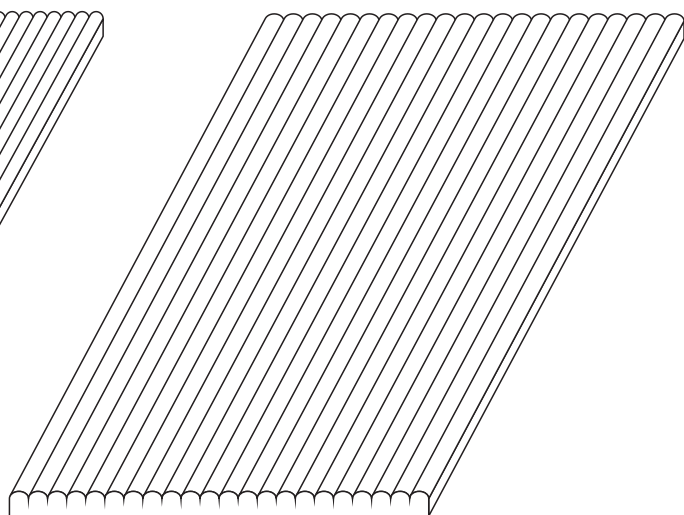

Мал. № 125

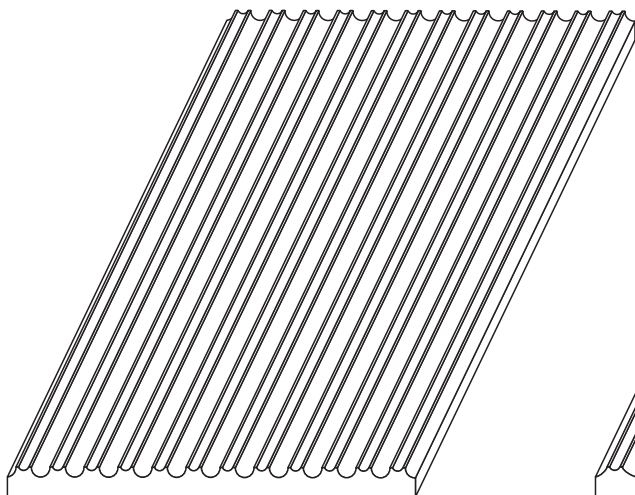

Мал. № 126

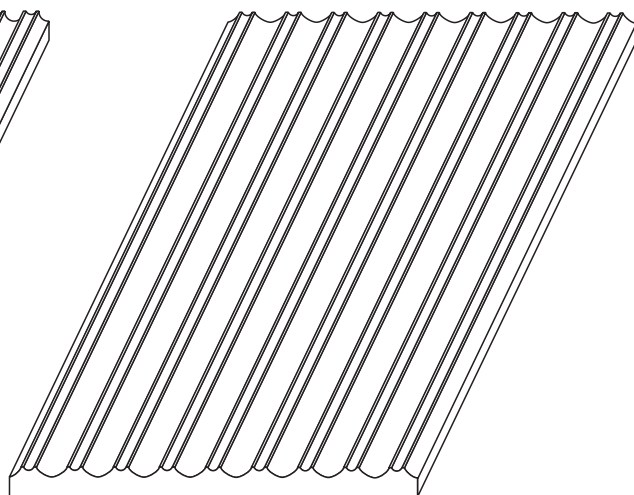

Мал. № 127